



Experts In Home Cleaning™

BIG GREEN™

deep cleaning machine

USER'S GUIDE

48F3 SERIES 220-240V

- 2 Thank You
- 3 Product Registration
- 3 Safety Instructions
- 4-5 Product View
- 6 Assembly
- 6-12 Operations
- 13-15 Maintenance and Care
- 16 Troubleshooting
- 17 Replacement Parts
- 18 Accessories
- 19 Warranty
- 20 Consumer Services



Thanks for buying a BISSELL Deep Cleaner

Thanks for buying a BISSELL Big Green deep cleaning machine. We're glad you purchased a BISSELL deep cleaner. Everything we know about floor care went into the design and construction of this complete, high-tech home cleaning system.

Your BISSELL Big Green deep cleaning machine is well made, and we back it with a limited one year warranty. We also stand behind it with a knowledgeable, dedicated Consumer Services department, so, should you ever have a problem, you'll receive fast, considerate assistance.

My great-grandfather invented the floor sweeper in 1876. Today, BISSELL is a global leader in the design, manufacture, and service of high quality homecare products like your Big Green deep cleaning machine.

Thanks again, from all of us at BISSELL.

Mark J. Bissell
Chairman, President & CEO

IMPORTANT SAFETY INSTRUCTIONS

When using an electrical appliance, basic precautions should be observed, including the following:

WARNING READ ALL INSTRUCTIONS BEFORE USING YOUR BIG GREEN DEEP CLEANING MACHINE.

⚠ WARNING:

To reduce the risk of fire, electric shock, or injury:

- Operators shall be adequately instructed on the use of the machine.
- This machine is not suitable for picking up hazardous dust..
- This machine shall be stored indoors only.
- Do not allow the supply cord to come into contact with the rotating brushes.
- If foam or liquid escapes from the machine, switch off immediately.
- Clean the water level limiting device regularly and examine it for signs of damage
- Do not immerse.
- Use only on surfaces moistened by cleaning process.
- Always connect to a properly grounded outlet.
- See Grounding Instructions.
- Unplug from outlet when not in use and before conducting maintenance or troubleshooting.
- Do not leave machine when it is plugged in.
- Do not service machine when it is plugged in.
- Do not use with damaged cord or plug.
- If appliance is not working as it should, has been dropped, damaged, left outdoors, or dropped into water, have it repaired at an authorized Service Center.
- Use indoors only.
- Do not pull or carry by cord, use cord as a handle, close door on cord, pull cord around sharp corners or edges, run appliance over cord, or expose cord to heated surfaces.
- Unplug by grasping the plug, not the cord.
- Do not handle plug or appliance with wet hands.
- Do not put any object into appliance openings, use with blocked opening, or restrict air flow.
- Do not expose hair, loose clothing, fingers or body parts to openings or moving parts.
- Do not pick up hot or burning objects.
- Do not pick up flammable or combustible materials (lighter fluid, gasoline, kerosene, etc.) or use in the presence of explosive liquids or vapor.
- Do not use appliance in an enclosed space filled with vapors given off by oil base paint, paint thinner, some moth proofing substances, flammable dust, or other explosive or toxic vapors.
- Do not pick up toxic material (chlorine bleach, ammonia, drain cleaner, gasoline, etc.).
- Do not modify the 3-prong grounded plug.
- Do not allow to be used as a toy.
- Do not use for any purpose other than described in this user's guide.
- Do not unplug by pulling on the cord.

- Use only manufacturer's recommended attachments.
- Always install float before any wet pick up operation.
- Use only cleaning products formulated by BISSELL for use in this appliance to prevent internal component damage. See the cleaning fluid section of this guide.
- Keep openings free of dust, lint, hair, etc.
- Do not point attachment nozzle at people or animals
- Keep appliance on a level surface.
- Do not use without intake screen filter in place.
- Turn off all controls before unplugging.
- Unplug before attaching the TurboBrush™.
- Be extra careful when cleaning stairs.
- Close attention is necessary when used by or near children.
- This appliance is not intended for use by persons (including children) with reduced physical, sensory or mental capabilities, or lack of experience and knowledge, unless they have been given supervision or instruction concerning use of the appliance by a person responsible for their safety.
- Children should be supervised to ensure that they do not play with the appliance.
- If the supply cord is damaged, it must be replaced by the manufacturer, its service agent or similarly qualified persons in order to avoid a hazard.

SAVE THESE INSTRUCTIONS.

THIS MODEL IS FOR HOUSEHOLD AND COMMERCIAL USE.

While used for normal household use, or used for normal house-keeping purposes in hotels, offices, schools, hospitals and similar premises, it is defined as for household use.

While used for rental businesses and used in hotels, schools, hospitals, factories, shops, offices for other than normal housekeeping purposes, it is defined as for commercial use.

⚠ WARNING: This appliance must be Earthed.

IMPORTANT: FOR OPERATION ON A 220-240 VOLT A.C. 50/60 Hz POWER SUPPLY ONLY.

If your appliance is fitted with a nonrewire-able BS 1363 plug it must not be used unless a 13 amp (ASTA approved to BS 1362) fuse is fitted in the carrier contained in plug. Spares may be obtained from your BISSELL supplier. If for any reason the plug is cut off, it must be disposed of, as it is an electric shock hazard should it be inserted into a 13 amp socket.

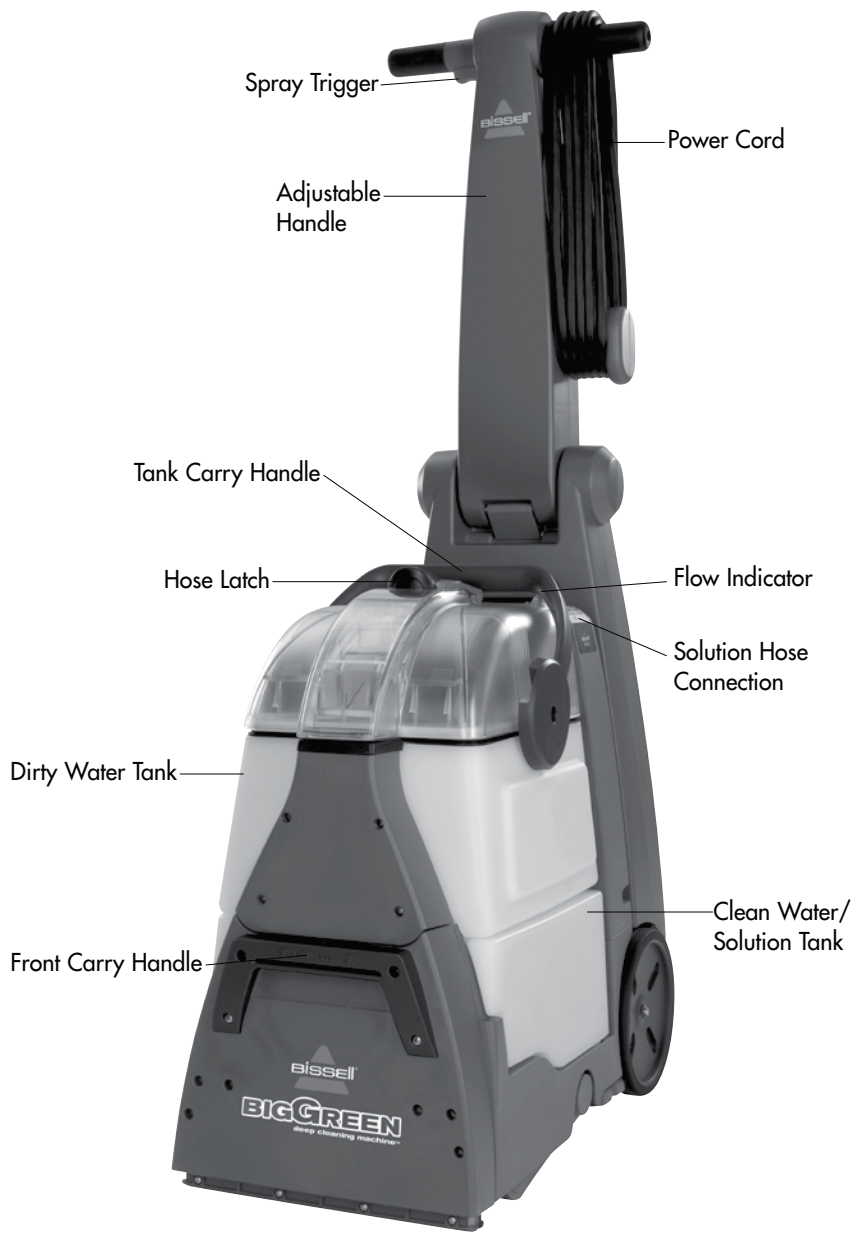

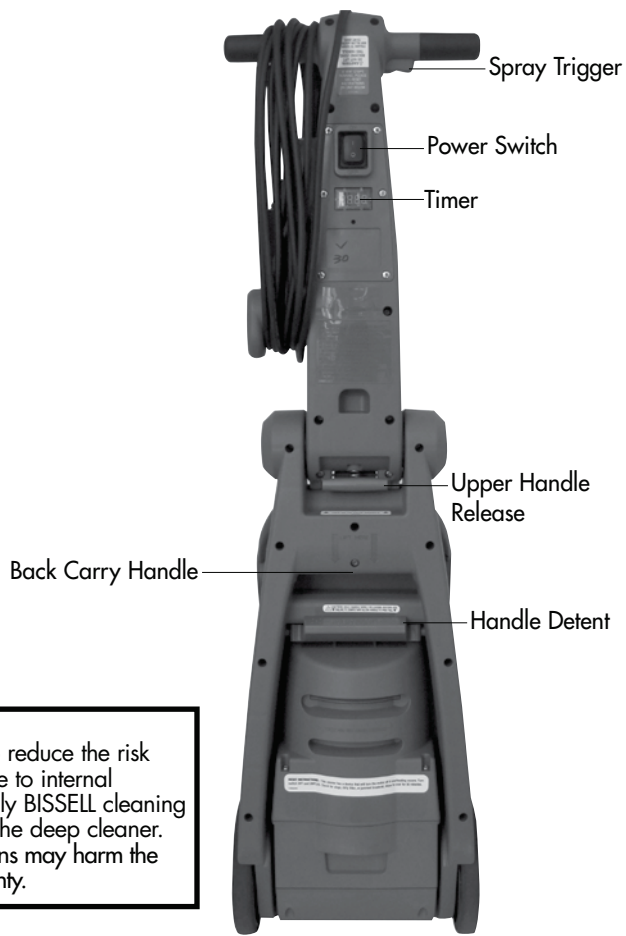

WARNING: To reduce the risk of fire and electric shock due to internal component damage, use only BISSELL cleaning fluids intended for use with the deep cleaner. Non-BISSELL cleaning solutions may harm the machine and void the warranty.

Cleaning fluid

Keep plenty of genuine BISSELL 2X formula on hand so you can clean and protect whenever it fits your schedule. Always use genuine BISSELL deep cleaning formulas. Non-BISSELL cleaning solutions may harm the machine and will void the warranty.



946 mL
BISSELL
Advanced
Deep
Cleaning
Formula



946 mL
BISSELL
2X Pet Deep
Cleaning
Formula



946 mL
BISSELL
Oxy
Cleaning
Formula



946 mL
BISSELL
Allergen
Deep
Cleaning
Formula



946 mL
BISSELL
Pet Urine
Stain and
Odour Trigger
Formula



946 mL
BISSELL
Heavy
Traffic™
Trigger
Formula



651 mL
BISSELL
Oxy Deep™
Pro
Trigger
Formula

Assembly

Your BISSELL Big Green deep cleaning machine comes with no assembly required!

Operations

Before you clean

1. Move furniture to another area if cleaning the entire room (optional.)
2. Vacuum area with a dry vacuum cleaner thoroughly before deep cleaning.
3. Plan your cleaning route to leave an exit path. It is best to begin cleaning in the corner farthest from your exit.
4. Pretreating (optional) is recommended to improve cleaning effectiveness for heavily soiled carpet in high traffic areas such as entryways and hallways.
 - A. Spray the BISSELL Heavy Traffic™ Pre-Treat formula onto high traffic areas, soiled areas or stains.
 - B. Allow to penetrate for at least three minutes.
 - C. Clean as normal using your BISSELL Big Green deep cleaning machine, following the instructions on page 7.



ATTENTION:

Some Berber carpets have a tendency to fuzz with wear. Repeated strokes in the same area with an ordinary vacuum or deep cleaner may aggravate this condition. Please see Stain Removal instructions on page 12.

Operations

Carpet cleaning

1. Remove dirty water tank. Pull dirty water tank handle to upright position and lift up to remove dirty water tank.
2. Lift clean water/solution tank from the base of machine.
 - A. Unscrew cap on top of the clean water tank. Fill tank to **FILL** line with clean, hand hot tap water.
 - B. Measure BISSELL formula using cap on tank. Fill cap to line twice for each full tank of water. Always use genuine BISSELL formulas to maximize cleaning and for the safety of your machine
 - C. Screw cap back onto clean water/solution tank and place tank onto base of the machine.
3. Replace dirty water tank securely on top of the clean water/solution tank and push handle back to lock into place.
4. Plug into a proper outlet and turn the power switch to the ON (I) position.
5. Detent handle by pushing down on the green lever on the back of the machine while pulling back.
6. **Cleaning strokes.** While pressing the trigger, make one slow forward wet pass and another back. Let the formula and DirtLifter PowerBrushes do the work for you.

Note: Your machine is equipped with a circuit breaker that will automatically shut off the brush if a large or loose object is caught in the brush roll. If that happens, be sure to unplug your machine, remove the foreign object and then plug machine in to reset the circuit breaker.

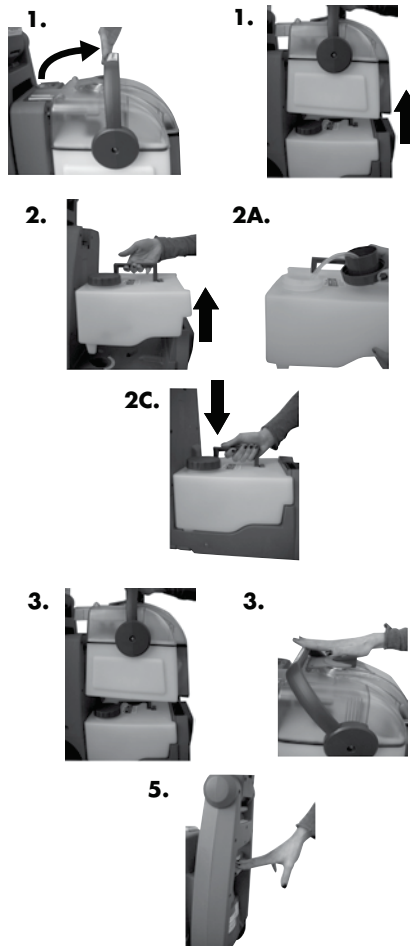

Keep plenty of genuine BISSELL 2X formula on hand so you can clean whenever it fits your schedule. Always use genuine BISSELL deep cleaning formulas. Non-BISSELL cleaning solutions may harm the machine and void the warranty.

Carpet cleaning continued

7. **Cleaning strokes.** Release the trigger and make one slow forward and backward pass over the same area to remove any residual dirty water and aid in drying. Repeat cleaning passes until solution being pulled up appears clean. Continue passes without pressing the trigger until you can't see any more water being pulled up.
8. Remove the dirty water tank by pulling the handle to the upright position and lift up. Carry the tank like a bucket to a utility sink or outside where you will dispose of the dirty water.
9. Unlatch the top of the tank from the bottom by pushing the handle all the way forward and lifting the top off. Pour dirty water into the sink.
Note: You may notice hair and debris deposits on the carpet or in the tank that were loosened by the cleaning action (especially with newer carpets that have never been deep cleaned before). This debris should be picked up and thrown away.
10. Fill the clean water/solution tank with clean hand hot tap water and follow Operations instructions 2 - 7 to continue cleaning.

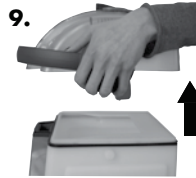
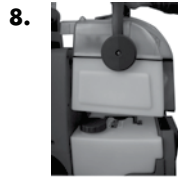

⚠ CAUTION:
Do not overwet. Take care not to run over loose objects or edges of area rugs. Stalling brush may result in premature belt failure.

Cleaning with attachments

Your Big Green deep cleaning machine may have come with a hose and at least one attachment for cleaning stairs, upholstery and more.

- 1. Important!** If using to clean upholstery, check upholstery tags.
 - A.** Check manufacturer's tag before cleaning. "W" or "WS" on the tag means you can use your Big Green deep cleaning machine. If the tag is coded with an "X" or an "S" (with a diagonal stripe through it) or says "Dry Clean Only", do not proceed with any deep cleaning machine. Do not use on velvet or silk. If manufacturer's tag is missing or not coded, check with your furniture dealer.
 - B.** Check for colourfastness in an inconspicuous place.
 - C.** If possible, check upholstery stuffing. Coloured stuffing may bleed through fabric when wet.
 - D.** Plan activities to allow upholstery time to dry.
 - E.** Vacuum thoroughly to pick up loose debris and pet hair. Use a vacuum with a brush attachment and a crevice tool to clean in fabric folds.

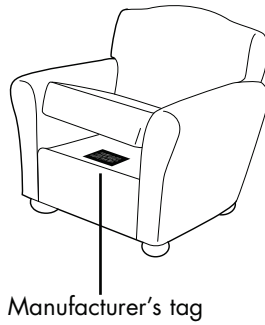

- 2.** Fill the clean water/solution tank. Lift clean water/solution tank from the base of machine.
 - A.** Unscrew cap on top of the clean water/solution tank. Fill tank to **FILL** line with clean, hand hot tap water.
 - B.** Measure BISSELL formula using cap on tank. Fill cap to line twice for each full tank of water. Always use genuine BISSELL formulas to maximize cleaning and for the safety of your machine.
 - C.** Screw cap back onto clean water/solution tank and place tank onto base of the machine.

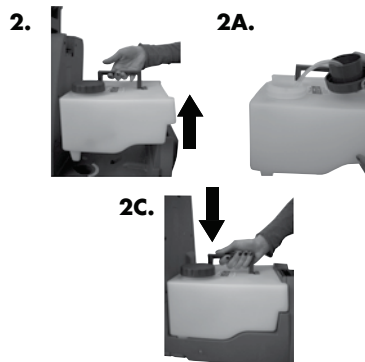

Cleaning with attachments continued

3. Attach Hose

- A. Connect solution hose to the hose connection point on unit, next to flow indicator. Insert hose and turn clockwise until locked into place.
- B. Open hose latch on the front of the unit and insert hose into place. Turn clockwise until locked into place.



4. Attach the cleaning tool to the end of the hose.

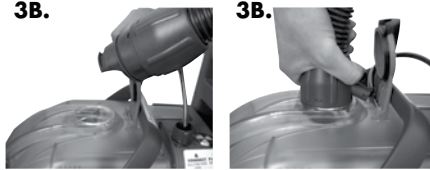

- 5. Clean by pressing the red trigger to spray solution onto the area to be cleaned. Slowly move the tool back and forth over the soiled surface. Release the trigger to suction soiled water. Continue to clean in the area, working in small sections, until no more dirt can be removed. **Caution: Do Not Overwet**

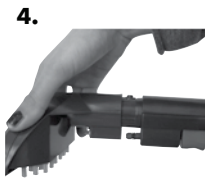

- 6. Remove and rinse tool in clean running water. Let dry completely.

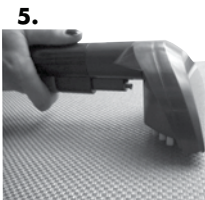

- 7. Empty dirty and clean water/solution tanks and rinse following instructions on page 8, step 8-9.

Cleaning with Oxy Gen2™ tool

Select models only

- 1.** Follow instruction on page 10 to attach hose to machine.
- 2. To pretreat heavy traffic areas:**
 - A.** Pour Oxy GEN2 formula into the Oxy GEN2 Tool and attach tool to your machine's hose.
 - B.** Hold tool 2-4 inches above the floor and press red trigger to spray onto carpet.
 - C.** Wait for 3-5 minutes then clean as normal using your machine
- 3. To use as a spot and stain tool on carpet:**
 - A.** Pour Oxy GEN2 formula into the Oxy GEN2 Tool and attach tool to your machine's hose.
 - B.** Hold tool 1-2 inches above the floor and press trigger to spray onto carpet. Spray generously, but do not overwet the carpet.
 - C.** Move the bristles back and forth over the spot.
 - D.** Suction up solution/stain immediately with your tool.
 - E.** Repeat as needed.



Stain Removal

Do Not Delay! Attending to an accident soon after it occurs ensures the most optimal clean. Leaving it for an extended period of time may cause it to set and become permanent



1. Blot up liquids with an absorbent cloth or paper towels. White materials are recommended because certain dyes may bleed and make the stain worse.
2. Gently scrape up any semi-solids with a spoon or spatula. Do not use a knife or other utensil with sharp edges because it could damage the carpet or upholstery.
3. If the area has dried, remove the remaining semi-solids and residue with a sweeper or vacuum.
4. Be sure to test any spot removal formulas in an inconspicuous area first. This is important as some dyes and materials could be damaged or discolored by cleaning solvents. If such a change should occur, try a different solution or call a professional.
5. If cleaning on Berber carpeting, gently run your machine over a hidden area. If no fuzzing occurs, continue cleaning in soiled area.
6. Using the BISSELL Heavy Traffic PreCleaner, spray evenly over soiled area. **DO NOT OVERWET.** Wait 3-5 minutes. Gently work the solution by blotting area with a clean, damp, color safe cloth.
7. Clean using the unit or the hose with attachment.

Maintenance and care

Machine storage

Once your cleaning is complete, make sure both the dirty and clean water/solution tanks are emptied, rinsed out and dried before the next use.

Note: Store cleaner in a protected, dry area. Since this product uses water, it must not be stored where there is a danger of freezing. Freezing will damage internal components and void the warranty.

Machine care

For best results, a few simple steps can assure your machine is well maintained after your cleaning is complete

- 1.** Turn power OFF (0). Unplug the machine and wrap the power cord.
- 2.** After emptying the clean water/solution and dirty water tanks, rinse them out with running hand hot tap water.
- 3.** The top half of the dirty water tank can also be rinsed clean through the nozzle area.
- 4.** To clean attachments, remove from hose and rinse in clean, running water and let dry. Clean the hose by removing it from the machine and let running tap water run through both ends.
- 5.** After carpet is dry, vacuum again to remove hair and fuzz.

Maintenance and care

Belt removal and replacement

1. Turn off the machine and unplug it from the outlet.
2. Remove the dirty and clean water/solution tanks from the base of the machine.
3. While standing behind the unit, lay the unit on its side (cord side up)
4. Looking at the bottom of unit, find the back center of the brush carriage where the carriage latch is located. It is between the brush assembly and the front wheels.
5. Pull brush carriage towards you with one hand until it stops, then pinch the carriage latch with other hand while pulling the carriage towards you. The carriage should swing out to access belt cover.
6. Remove three screws from cover. Lift and remove to access brush carriage.
7. Turn the belt inward towards the large pulley while lifting out.
8. Place new belt over small pulley first and then slip the belt over the large pulley.
9. Replace the brush carriage and screws.
10. Push brush carriage back into place making sure the carriage latch locks back into place.



WARNING:

To reduce the risk of fire, electric shock, or injury, turn power OFF and disconnect plug from electrical outlet before performing maintenance or troubleshooting.

3.



4.

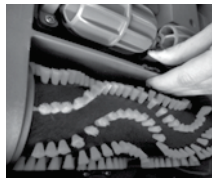

5.



6A.



6B.



7.

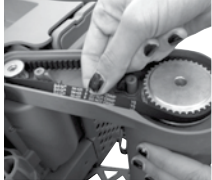

8.



9.



10.



Maintenance and care

Brush removal and replacement

1. Turn OFF (0) the machine and unplug from the outlet.
2. Remove the dirty and clean water/solution tanks from the base of the machine.
3. While standing behind the unit, lay the unit on its side (cord side down).
4. Looking at the bottom of the unit, find the center of the brush carriage where the carriage latch is located. It is between the brush assembly and wheels.
5. Pull the brush carriage towards you with one hand until it stops. Pinch the carriage latch with the other hand while pulling the carriage towards you. The carriage should swing out to access brush end cover.
- 6A. Remove three screws from endcap.
- 6B. Pull endcap off to release brush roll.
7. With cover removed, the brush comes out easily by tilting the loose end out of the carriage.
8. To replace the brush roll back into the unit, place the large open end of the brush onto the carriage and tilt opposite end back into place.
9. With the brush sitting relatively straight up and down by itself, place endcap back on top and replace three screws.
10. Spin the brush by hand to make sure it turns freely with some minor resistance from the motor. Push brush carriage back into place with a light pull against the lock.

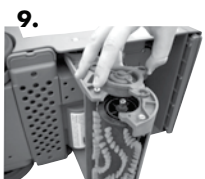
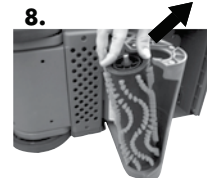
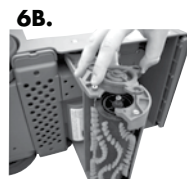
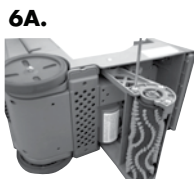
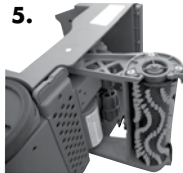
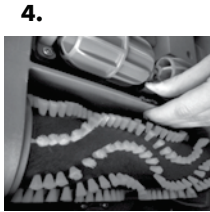
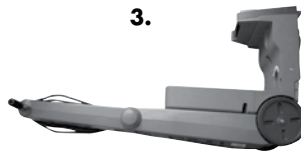

Troubleshooting



WARNING:

To reduce the risk of fire, electric shock, or injury, turn power OFF and disconnect plug from electrical outlet before performing maintenance or troubleshooting.

Reduce Spray or No Spray

Possible causes

1. Water tank may be empty
2. Tank may not be seated completely
3. Pump may have lost prime.
4. Debris filter on base is clogged

Remedies

1. Fill clean water/solution tank with hand hot tap water
2. Turn power OFF (0). Remove and reseal tank.
3. Turn power OFF (0) and then back ON (1). Wait one minute, then depress trigger
4. Use hand to remove debris

DirtLifter™ PowerBrush does not turn

Possible causes

1. The belt is off or broken
2. The unit is in the upright position
3. Circuit breaker on machine may have tripped

Remedies

1. Turn power OFF (0) and unplug unit from outlet. Follow instructions on page 14
2. Brushes only rotate when unit is reclined using the detent pedal
3. Turn the machine OFF (0) and unplug from outlet. Check to see if foreign object is caught in brush roll. Remove object. Plug machine in to reset circuit breaker

Cleaner not picking up solution

Possible causes

1. Tanks may not be seated properly
2. Clean water/solution tank is empty
3. Dirty water tank has picked up the maximum amount of dirty water the red float door has closed
4. Red float "door" in the tank may have closed as a result of bumping an object or moving machine back and forth too quickly
5. Front nozzle of machine is clogged
6. Upper body filter is clogged

Remedies

1. Pick up both the clean water/solution and dirty water tanks and reseal them so they fit snugly on the unit
2. Check fluid levels in clean water tank and refill if necessary
3. Empty dirty water tank. Refill clean water tank with water and formula. Place both tanks back onto unit
4. Turn the machine OFF(0), allowing red float door to release into the open position,. Turn the unit back ON (1) to continue cleaning. Be sure your forward and backward strokes are completed at a slower pace
5. Use fingers to remove any debris from this area
6. Use fingers to remove any debris from this area

Other maintenance or service not included in the manual should be performed by an authorized service representative.

Thank you for selecting a BISSELL product.

Please do not return this product to the store.

Replacement parts -

Item	Part No.	Part Name
1	203-7443	Hose assembly
2	203-7451	Float
3	203-7452	Dirty tank assembly
4	203-7454	Clean tank assembly
5	203-7455	Clean tank cap assembly
6	203-7458	Brush roll assembly
7	203-7459	Brush endcap
8	203-7460	Belt- brush roll

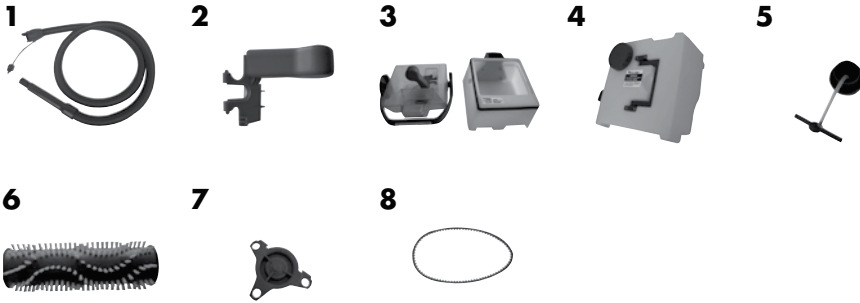

Accessories

Item	Part No.	Part Name
1	203-6651	3" Tough Stain Tool
2	203-6652	Powered TurboBrush™ Hand Tool
3	203-6653	4" Upholstery Tool
4	203-6654	6" Stair Tool
5	203-6655	Spraying Crevice Tool
6	203-6655	2-in-1 Crevice Tool
7	203-7240	Oxy Gen2 Tool
8	82M1-E	946 mL BISSELL Advanced Deep Cleaning Formula
9	27F2-E	946 mL BISSELL 2X Pet Deep Cleaning Formula
10	84E7-E	946 mL BISSELL Oxy Cleaning Formula
11	54B6-E	946 mL BISSELL Allergen Deep Cleaning Formula
12	64V9-E	650 mL BISSELL Pet Urine Stain & Odour Trigger Formula
13	30M1-E	650 mL BISSELL Heavy Traffic Trigger Formula
14	31U5-E	650mL BISSELL Oxy Deep Pro Trigger Formula

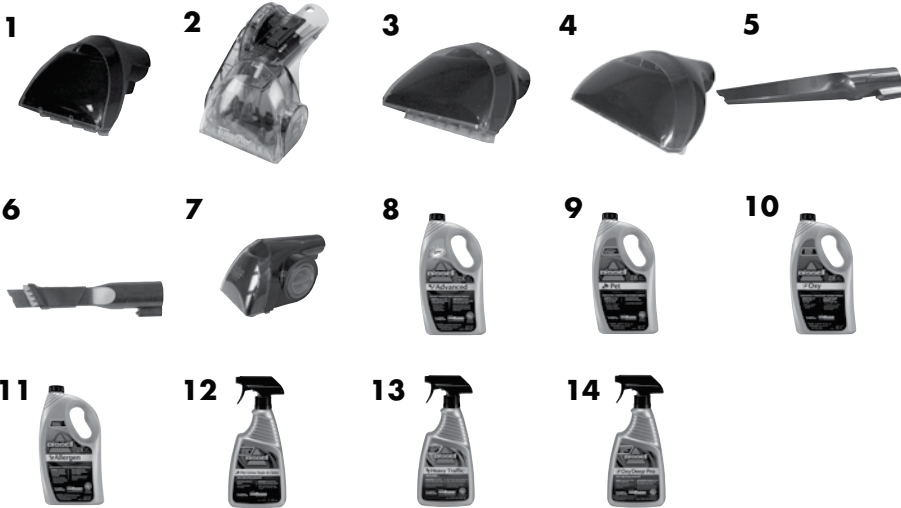

Warranty - BISSELL Big Green deep cleaning Machine

This warranty gives you specific legal rights, and you may also have other rights which may vary from country to country. If you need additional instruction regarding this warranty or have questions regarding what it may cover, please contact BISSELL Consumer Services by E-mail, telephone, regular mail as described below, or contact your local in country distributor.

Limited One Year Warranty

Subject to the *EXCEPTIONS AND EXCLUSIONS identified below, BISSELL Homecare, Inc. will repair or replace (with new or remanufactured components or products), at BISSELL's option, free of charge from the date of purchase by the original purchaser, for one year any defective or malfunctioning part due to manufacturer defect.

See "BISSELL Consumer Services" information below.

This warranty applies to product used for personal, and not commercial or rental service. This warranty does not apply to fans or routine maintenance components such as filters, belts, or brushes. Damage or malfunction caused by negligence, abuse, neglect, unauthorized repair, or any other use not in accordance with the User's Guide is not covered.

BISSELL Consumer Service:

If your BISSELL product should require service or if you need information about repairs, authorized service centers in your area, replacement parts or your warranty, please contact BISSELL Consumer Services, as indicated below, or contact your local in country distributor.

For UK inquiries:

Monday - Thursday 9 am — 5 pm
Friday 9 am — 4 pm

BISSELL Homecare (Overseas) Inc.

Ground Floor
226 Berwick Avenue
Slough
Berkshire, SL1 4QT
United Kingdom
Telephone: 0844-888-0870

For all other inquiries:

Monday - Friday 8 am — 4 pm

BISSELL Homecare, Inc.

PO Box 1888
Grand Rapids, Michigan 49501 USA
Telephone: 01-616-453-4451
Fax: 01-616-453-1383

BISSELL HOMECARE, INC. IS NOT LIABLE FOR INCIDENTAL OR CONSEQUENTIAL DAMAGES OF ANY NATURE ASSOCIATED WITH THE USE OF THIS PRODUCT. BISSELL'S LIABILITY WILL NOT EXCEED THE PURCHASE PRICE OF THE PRODUCT.

*EXCEPTIONS AND EXCLUSIONS FROM THE TERMS OF THE LIMITED WARRANTY

THIS WARRANTY IS EXCLUSIVE AND IN LIEU OF ANY OTHER WARRANTIES EITHER ORAL OR WRITTEN. ANY IMPLIED WARRANTIES WHICH MAY ARISE BY OPERATION OF LAW, INCLUDING THE IMPLIED WARRANTIES OF MERCHANTABILITY AND FITNESS FOR A PARTICULAR PURPOSE, ARE LIMITED TO THE ONE YEAR DURATION FROM THE DATE OF PURCHASE AS DESCRIBED ABOVE.



For information about repairs or replacement parts, or questions about your warranty, call:

BISSELL Consumer Services

Or visit the BISSELL website - www.bissell.com

For UK inquiries:

Monday - Thursday 9 am — 5 pm
Friday 9 am — 4 pm

BISSELL Homecare (Overseas) Inc.

Ground Floor
226 Berwick Avenue
Slough
Berkshire, SL1 4QT
United Kingdom
Telephone: 0844-888-0870

For all other inquiries:

Monday - Friday 8 am — 4 pm

BISSELL Homecare, Inc.

PO Box 1888
Grand Rapids, Michigan 49501 USA
Telephone: 01-616-453-4451
Fax: 01-616-453-1383

When contacting BISSELL, have model number of cleaner available.

Please record your Model Number: _____

Please record your Purchase Date: _____

NOTE: Please keep your original sales receipt. It provides proof of purchase date in the event of a warranty claim. See Warranty on page 19 for details.



©2011 BISSELL Homecare, Inc
Grand Rapids, Michigan
All rights reserved. Printed in China
Part Number 120-4351
Rev 3/11
Visit our website at:
www.bissell.com
Scotchgard is a trademark of 3M

